



155ml Round Container

FR Series

Product Specifications

Container

Product Code:	FR0155
Description:	155ml Round Container
Brimful Volume:	173 ml
ISO Volume:	157 ml
Tamper Evident:	Yes

Material



Tub:	Polypropylene
Lid:	Polypropylene

Weight

Tub:	6 grams
Lid:	2 grams

Performance

Storage Temperature:	0°C - 40°C*
Shelf Life:	Minimum 12 months
Static Load on bottom Pail:	Maximum 4 kg at 20°C
Suitable for Hot Filling:	Yes* (Above 70°C See note)
Suitable for Tinting:	No

Compatibility

Some chemicals, and process parameters, can affect the integrity of the container. The buyer must undertake testing and approval for the container's suitability for the product and application.

Regulatory

Raw materials used are REACH compliant, approved for food contact and meet FDA regulations.



Decoration

Tub IML:	Yes
Lid IML:	Yes
Colours:	White, Clear, others on request

Palletisation

Lid Pallet Quantity:	60480
Bucket Pallet Quantity(Empty):	19200
Units per layer:	238
Bucket Pallet Quantity (Filled):	4046

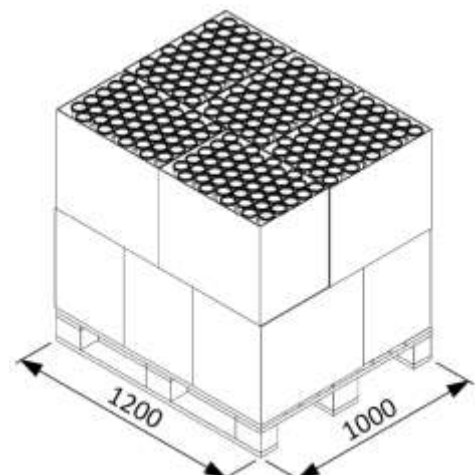

Standard tolerance of ±5%

*Special blends and additives available for non standard conditions.

Specifications can be modified without notice; please contact your OnePlastics representative to ensure you have the most recent information.